

➤ **Features/特征:**

- Single color/单色
- High bright output/高亮度输出
- Low power consumption/低功耗
- High reliability and long life/
可靠性高、寿命长

➤ **Descriptions/描述:**

- Dice material/芯片材质: AlGaInP
- Emitting Color/发光颜色:
Super Bright YELLOW/ 高亮度黄色
- Device Outline/产品外形:
φ 3mm Round Type/ 3mm 圆形
- Lens Type 胶体颜色:
Water Clear/ 无色透明

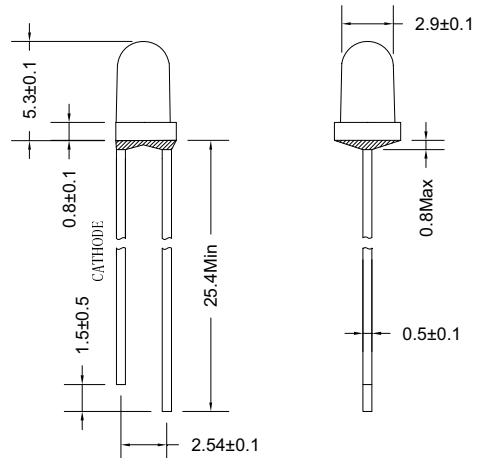
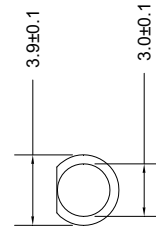

1. All dimensions are millimeters/单位: mm.
2. Tolerance is +/-0.25mm unless otherwise noted/
没有标注的公差均为±0.25mm.

➤ **Directivity/指向特性:**

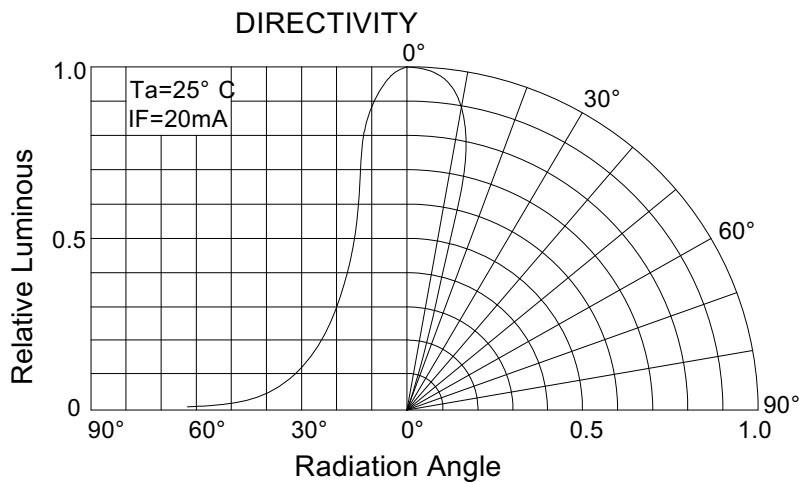

➤ **Absolute maximum ratings/极限参数 (Ta = 25°C)**

Parameter 参数	Symbol 符号	Test Condition 测试条件	Values 数值		Unit 单位
			Min.	Max.	
Reverse Voltage 反向电压	V _R	I _R = 30 μA	5	--	V
Forward Current 正向工作电流	I _F	----	----	30	mA
Power Dissipation 损耗功率	P _d	----	----	75	mW
Pulse Current 正向峰值电流	I _{peak}	Duty=0.1mS, 1kHz	----	100	mA
Operating Temperature 工作温度范围	T _{opr}	----	-40	+85	°C
Storage Temperature 储存温度范围	T _{str}	----	-40	+100	°C

➤ **Electrical and optical characteristics/光电参数 (Ta = 25°C)**

Parameter 参数	Symbol 符号	Test Condition 测试条件	Values 数值			Unit 单位
			Min.	Typ.	Max.	
Forward Voltage 正向电压	V _F	I _F =20mA	----	1.8	2.2	V
Reverse Current 反向电流	I _R	V _R =5V	----	----	30	μA
Dominant Wavelength 主波长	λ _d	I _F =20mA	----	589	----	nm
Peak Wavelength 峰值波长	λ _p	I _F =20mA	----	591	----	nm
Spectral Line half-width 半波长宽度	Δλ	I _F =20mA	----	20	----	nm
Luminous Intensity 发光强度	I _v	I _F =20mA	1500		3000	mcd
Viewing Angle 指向角度	2θ _{1/2}	I _F =20mA	----	24	30	deg.

BIN ranking for LEDs

BRIGHTNESS BIN

Bin Code	IV(mcd)	Bin Code	IV(mcd)	Bin Code	IV(mcd)	Bin Code	IV(mcd)
A	0-5.0	H	37.2-52.0	Q	390-550	X	4180--5860
B	5.0-7.0	J	52.0-72.8	R	550-770	Y	5860-8200
C	7.0-9.8	K	72.8-102	S	770-1100	Z1	8-10cd
D	9.8-13.7	L	102-145	T	1100-1520	Z2	10-12cd
E	13.7-19.0	M	145-200	U	1520-2130	Z3	12-14cd
F	19.0-26.6	N	200-280	V	2130-3000	Z4	14-16cd
G	26.6-37.2	P	280-390	W	3000-4180	Z5	16-18cd

WAVELENGTH BIN

Ligth Col.	Bin Code	Wavel. (nm)	Ligth Col.	Bin Code	Wavel. (nm)
BLUE	B1	450-455	YELLOW GREEN	YG1	555-558
	B2	455-460		YG2	558-561
	B3	460-465		YG3	561-564
	B4	465-470		YG4	564-567
	B5	470-475		YG5	567-570
	B6	475-480		YG6	570-573
BLUE GREEN	G1	491-494		YG7	573-576
	G2	494-497	YELLOW	Y1	582-585
	G3	497-500		Y2	585-588
	G4	500-503		Y3	588-591
	G5	503-506		Y4	591-594
	G6	506-509		Y5	594-597
	G7	509-512	YELLOW ORANGE	YO1	597-600
	G8	512-515		YO2	600-603
PURE GREEN	G9	515-518	YO3	603-606	
	G10	518-521	YO4	606-609	
	G11	521-524	PURE ORANGE	O1	609-612
	G12	524-527		O2	612-615
	G13	527-530	RED	O3	615-618
	G14	530-533		R1	618-621
	G15	533-536		R2	621-624
	G16	536-539		R3	624-627
	G17	539-542		R4	627-630
	G18	542-545		R5	630-633
	G19	545-548	R6	633-636	

FORWARD VOLTAGE (VF) BIN

Bin Code	VF (V)	Bin Code	VF (V)	Bin Code	VF (V)	Bin Code	VF (V)
V1	1.6-1.8	V5	2.4-2.6	V9	3.2-3.4	V13	4.0-4.2
V2	1.8-2.0	V6	2.6-2.8	V10	3.4-3.6	V14	4.2-4.4
V3	2.0-2.2	V7	2.8-3.0	V11	3.6-3.8	V15	4.4-4.6
V4	2.2-2.4	V8	3.0-3.2	V12	3.8-4.0	V16	4.6-4.8

➤ **Typical electrical/optical characteristic curves/光电特性曲线:**

Fig.1 正向电流 Vs. 正向电压

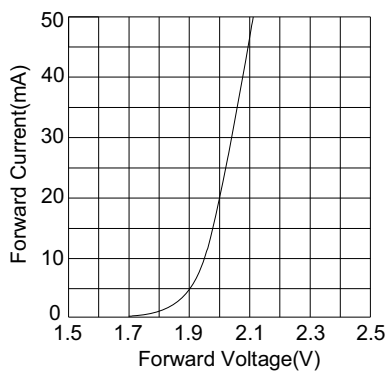

Fig.2 相对亮度 Vs. 正向电流

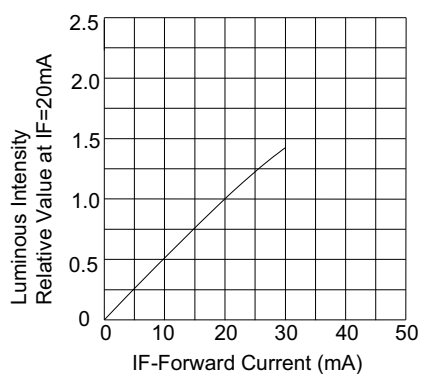

Fig.3 正向电流 Vs. 环境温度

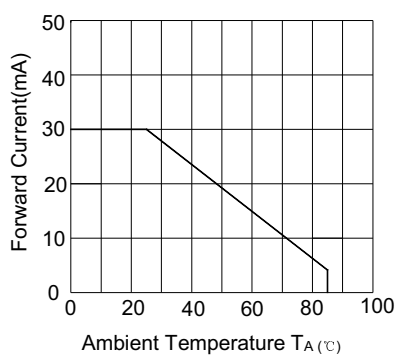

Fig.4 相对亮度 Vs. 环境温度

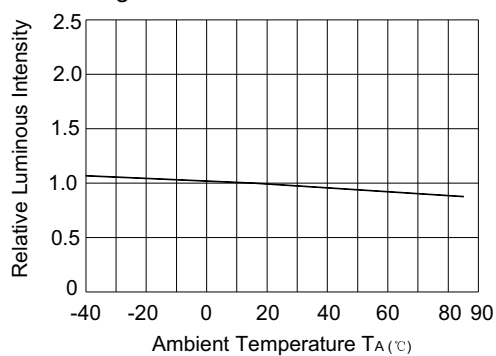

Fig.5 相对亮度 Vs. 波长

